

TN-2218, MRP Box (2 Meter) For 25 & 40 KVA DT's

FOR 5V/VN.L.

ANNEXURE-C1

1. RIPELEX GLASS 5 MM THICK WINDOW 150MM X 115 MM FOR METERING CHAMBER 45MM BELOW AS SHOWN
2. 12 BOLT AND HOLE FOR FIXING OF CAPACITOR
3. ONE 6 MM ISOLATED EARTH TERMINAL IN EARTH BUSHING CHAMBER TOWARDS NEUTRAL BUSHING WASHER FOR LUGS TIGHTENING
4. DOOR LOCK WITH UNIVERSAL KEY
5. OUTGOING 4 NOS SEPARATE (R, Y, B, N)
6. TERMINALS 50MM C/C CLEARANCE
7. LOUVERS TO PROVIDED BOTH SIDES AND BOTTOM OF CAPACITOR CHAMBER
8. 10 X 25 MM - 2 NOS EARHING BOLTS WITH 2 WASHERS AND ONE NUT
9. EARTH STICKERS - 3 NOS WITH TEXT PROVIDED
10. OUTGOING HOLE - 4 NOS WITH RUBBER GROMMET PROVIDED
11. HOLES DIA 32 FOR INTERNAL WIRING OF METER, MCCB, CAPACITORS ETC.
12. OUTGOING TERMINAL LUGS OF 25 SQ MM PROVIDED
13. DANGER PLATE 125 X 35 MM PROVIDED IN HINDI
14. DOOR HINGES ON TOP SIDE PROVIDED
15. 1" AT GASKET OF SIZE 20 X 2 MM FIXED WITH ADHESIVE PROVIDED IN SIDE DOOR
16. ALL CONNECTING WIRE ENDS SHOULD BE FITTED WITH PROPER LUGS

- NOTES
1. ALL DIMENSIONS ARE IN MM
 2. PANEL DOOR FRONT OPENABLE, PUSHING FITTING
 3. SHEET THICKNESS 2 MM
 4. PAINT SHADE I. ULTIVE GREEN SHADE SAME AS ON TRANSFORMER
 5. DEGREE OF PROTECTION IP33
 6. CABLE D/G FORK BOTTOM
 7. ALL LOUVERS TO PROVIDED WITH FINE WIRE MESH FORM INSIDE
 8. ALL DOOR HINGLS AND LOCK PATTIES SHALL BE WELDED

- IMPORTANT-
1. FIXING ARRANGMENT OF BACKLITE SHOULD BE AT ALL THE FOUR CORNERS
 2. CENTRE TO CENTRE DISTANCE FOR FIXING OF METER ON BACKLITE SHOULD BE AT 250 MM (MINIMUM)
 3. BACKLITE SHEET SHOULD BE OF SIZE 280X280X5 MM

NOTE: TERMINAL PLATES SHOULD BE FIXED AT A MINIMUM DISTANCE OF 60 MM FROM BOTTOM OF THE BOX

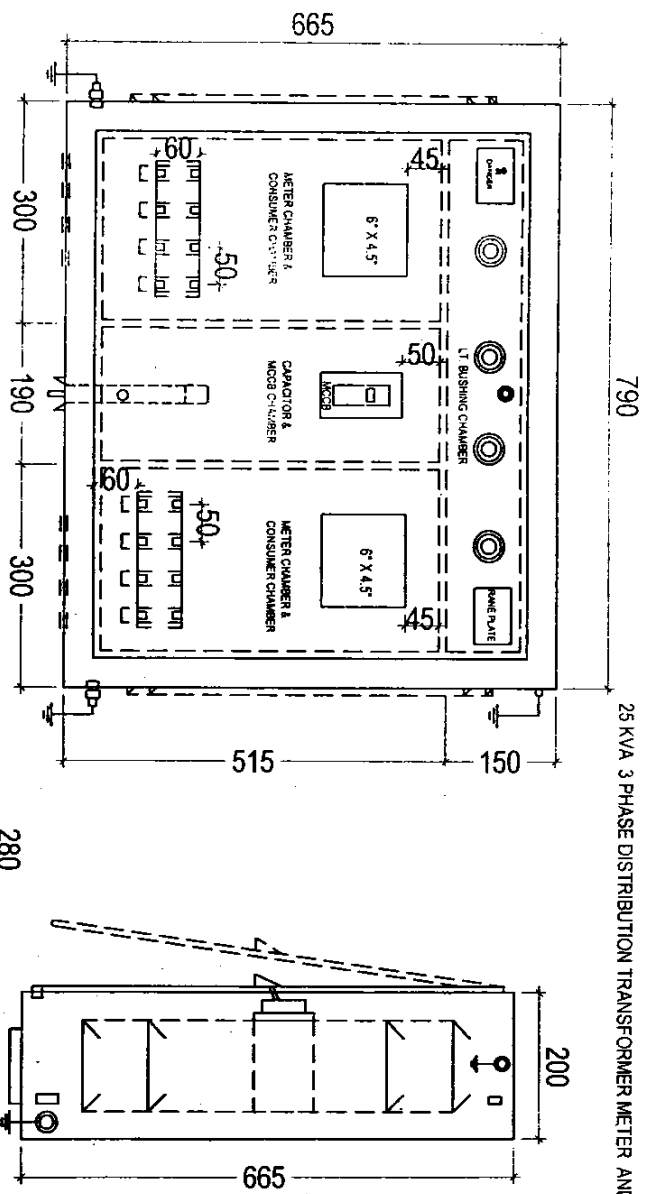

J. V. V. N. L. (MMP)
 Generally approved
 Subject to the observation
 vide our letter No..... Date.....
 AEN I/M SPT (S) SE (M)

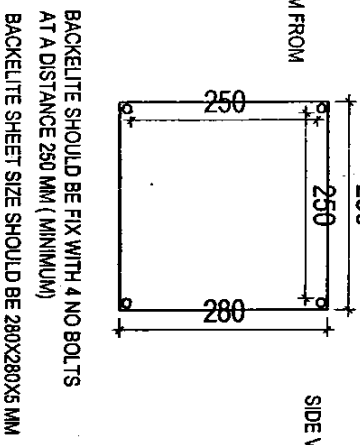

JAIPUR VIDYUT VITRAN NIGAM
 LIMITED, JAIPUR (RAJASTHAN)

GENERAL ARRANGMENT DRAWING OF 25 KVA DISTRIBUTION TRANSFORMER METER AND PROTECTION BOX
 25 KVA

DRAWING BY S.E. (MM) TN NO. 2218

MRP Box for 25KVA & 40KVA with provision of two meter.

TN-2218

DRG OF Deep drawn type metal box for Amperage - C3
25KVA & 40KVA.

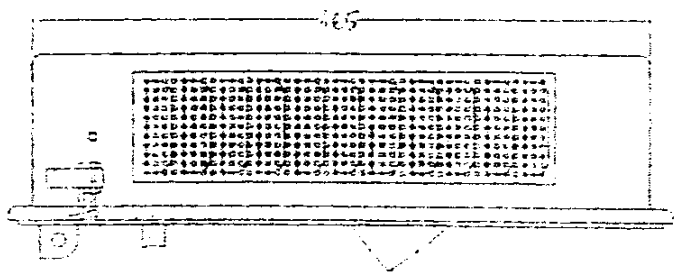

R/L SIDE VIEW

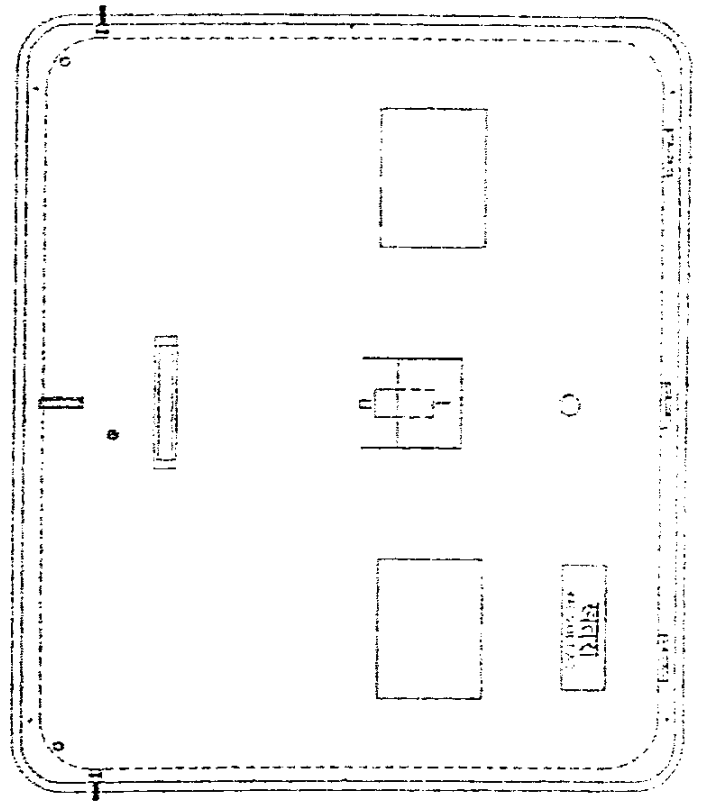

ELEVATION WHEN DOOR CLOSED

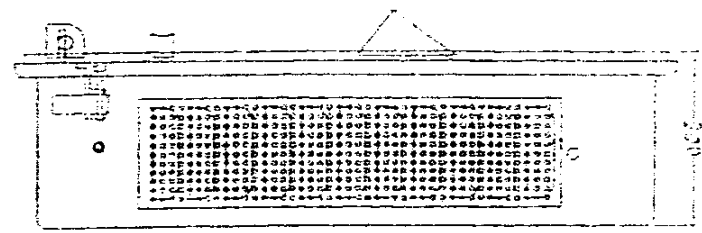

L/R SIDE VIEW

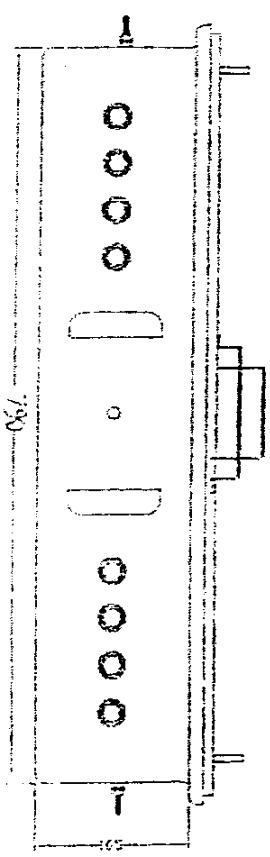

BOTTOM VIEW

A MASTER CUM PROTECTION BOX W.

TN-2218

DRG OF Deep drain type Meter box for 25kVA & 40kVA

Annexure - C3

BACK VIEW

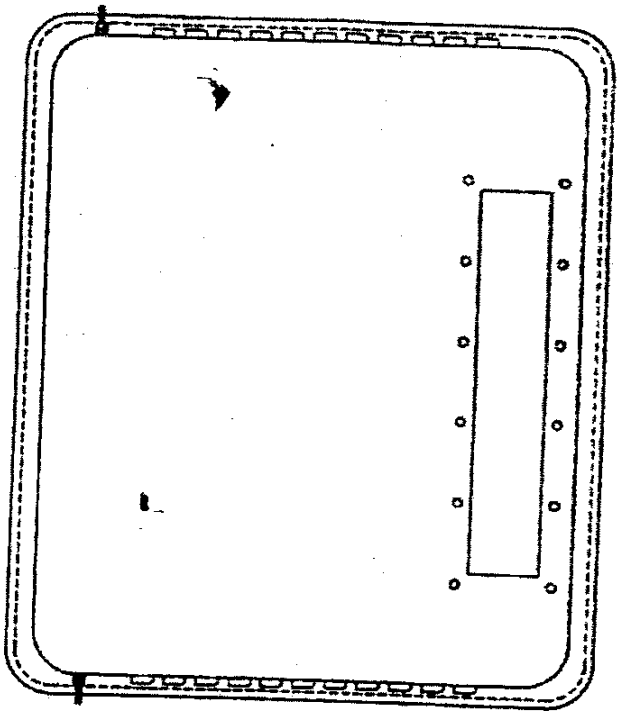

METER RELATING
INDICATOR SHEET

ELEVATION WHEN DOOR OPENED

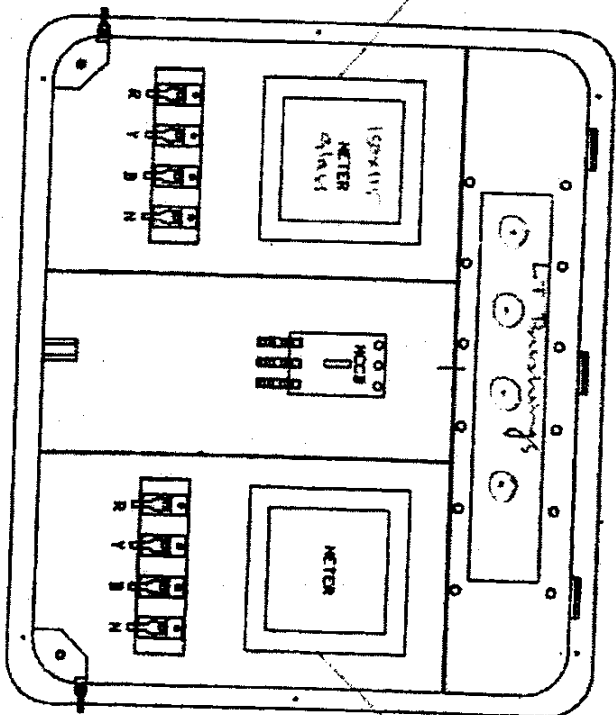

METER RELATING
INDICATOR SHEET